

A linear actuator system with 1-angstrom closed-loop control resolution and 50-millimeter travel range

Deming Shu, Yufeng Han, Thomas S. Toellner, and Esen E. Alp

Advanced Photon Source
Argonne National Laboratory
9700 S. Cass Av. Argonne, IL 60439, U.S.A.

ABSTRACT

We have designed and tested a novel linear actuator system with 1-angstrom closed-loop control resolution and 50-mm travel range.

There are two major ultraprecision motion control techniques that have been applied to this actuator:

- A novel laser Doppler encoder system with multiple-reflection optics.
- A specially designed high-stiffness weak-link mechanism with stacked thin metal sheets having sub-angstrom driving sensitivity with excellent stability.

In this paper, we present the system design and test results of this linear actuator. Applications of this new actuator system are also discussed.

Keywords: linear encoder, angular encoder, laser encoder, high resolution, actuator

1. INTRODUCTION

The Advanced Photon Source (APS) at the Argonne National Laboratory is a national user facility for synchrotron radiation research. The high-brilliance x-ray beams of this third-generation synchrotron radiation source provide powerful tools for forefront basic and applied research in the fields of materials science; biological science; physics; chemistry; environmental, geophysical, and planetary science; and innovative x-ray instrumentation. Instrument developers at the APS are facing many technical challenges. One of the challenges is to develop a state-of-the-art linear actuator system for x-ray instruments with ultrahigh resolution, stability, and a large dynamic range.

Since 1997, a prototype laser Doppler linear encoder (LDLE) with multiple reflections has been developed at the APS [1,2]. With a customized commercial laser Doppler displacement meter (LDDM) [3], this novel linear encoder achieved sub-angstrom sensitivity in a 300-mm measuring range. The laser Doppler displacement meter is based on the principles of radar, the Doppler effect, and optical heterodyning [4]. We have chosen a LDDM as our basic system, not only because of its high resolution (2 nm typical) and high measuring speed (2 m/s) but also because of its unique performance independent of polarization, which provides the convenience to create a novel multiple-reflection-based optical design to attain sub-angstrom linear resolution extension.

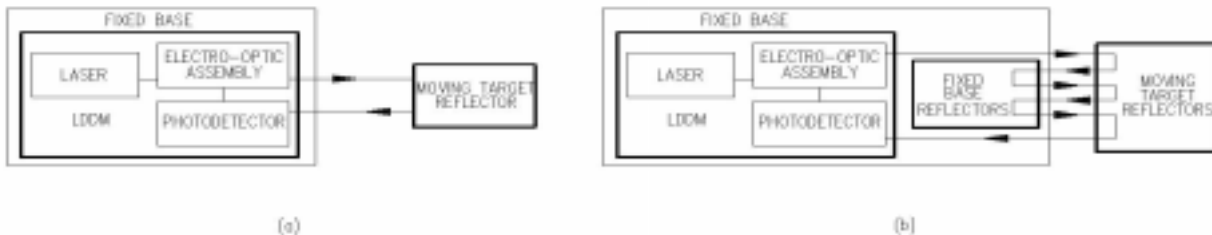

Fig. 1a. Schematic of the laser Doppler displacement measurement system.

Fig. 1b. Schematic of the laser Doppler displacement measurement system with multiple-reflection optics.

As shown in Fig. 1a, a commercial LDDM optical system includes four components: a frequency stabilized HeNe laser, an electro-optic assembly, a photodetector, which functions as a receiver, and a target reflector. The laser light reflected by the target is frequency-shifted by the motion of the target. The photodetector measures the phase variation caused by the frequency-shift, which corresponds to the displacement of the target. When the displacement is larger than the half-wavelength, $\lambda/2$, a counter records the total phase changes as:

$$\Delta\phi_{\text{total}} = 2\pi N + \phi, \tag{1}$$

where N is the number of half wavelengths, and ϕ is the phase angle less than 2π . The total target displacement, Δz , can be expressed as [5]:

$$\Delta z = \frac{c}{2f_0} (N + \phi/2\pi) \tag{2}$$

where f_0 is the frequency of the laser; and c is the speed of the light.

If we make the laser light reflect back and forth M times between the fixed base and the target before it finally reaches the photodetector, as shown in Fig. 1b, then introducing equation (2) gives

$$\Delta z = \frac{c}{2f_0 M} (N + \phi/2\pi) \tag{3}$$

which indicates that the multiple-reflection optics provides M -times resolution extension power for the system.

Figure 2 shows the self-aligning three-dimensional multiple-reflection optical design for the LDDM system resolution extension [6]. In this design, the heterodyning detector is housed coaxially inside the frequency-stabilized laser source. Instead of a typical single reflection on the moving target, the laser beam is reflected back and forth twelve times between the fixed base and the moving target. The laser beam, which is reflected back to the heterodyning detector, is frequency-shifted by the movement of the moving target relative to the fixed base. With the same LDDM laser source and detector electronics, this optical path provides twelve-times resolution extension power for the linear displacement measurement and encoding. The resolution of the custom-made commercial LDDM system that was used during this test, was 2 nm (1 nm LSB), so that, theoretically, a 0.166 nm resolution (0.083 nm LSB) was reached by the prototype LDLE system.

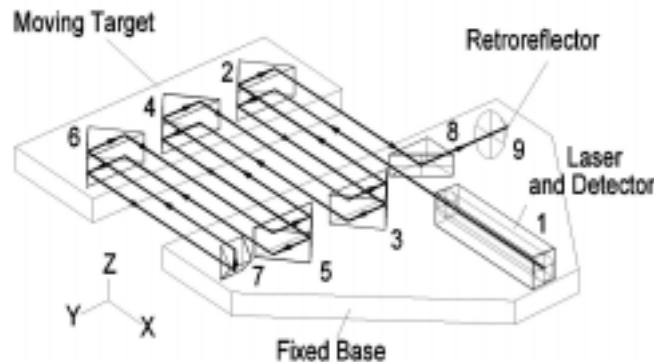

Fig. 2. Configuration of a self-aligning twenty-four reflection optical design. In this figure, item 1 is the frequency-stabilized laser source with heterodyning detector, items 2 – 8 are right-angle prisms, and item 9 is the end retroreflector.

This paper presents a novel linear actuator system with 1-angstrom closed-loop control resolution and a 50-mm travel range. The system is based on the LDLE and a specially designed high-stiffness weak-link mechanism having sub-angstrom driving sensitivity with excellent stability. In this paper, we first present the design of the high-stiffness weak-link motion reduction mechanism, followed by the design of a one-dimensional linear actuator system and its test results. The design of a two-dimensional linear actuator system and the applications of these new actuator systems are also discussed.

2. HIGH-STIFFNESS WEAK-LINK LINEAR MOTION REDUCTION MECHANISM

Besides a linear encoder with sub-angstrom resolution, an actuator and stage mechanism with near 0.3-angstrom driving sensitivity is needed to perform a linear motion closed-loop control at the 1-angstrom level. The stage design becomes a real technical challenge, especially when it needs to have a few kilogram loading capacity with high stiffness.

To overcome these obstacles, we have developed a novel stage using a high-stiffness weak-link mechanism. The precision and stability of this mechanism allow us to control the stage with near 0.3-angstrom driving sensitivity. Figure 3 shows the design principle of the weak-link mechanism [7]. The structure consists of four groups of redundant constrained weak-link parallelogram mechanisms as shown in Fig. 3(a). As shown in Fig. 3(b), while an initial angle α was set, the increment of the output motion ΔM_{out} can be expressed as:

$$\Delta M_{out} = \Delta M_{in} / \tan \alpha \mathbf{\Delta} \tag{4}$$

where ΔM_{in} is the increment of the input motion and α is the initial setup angle.

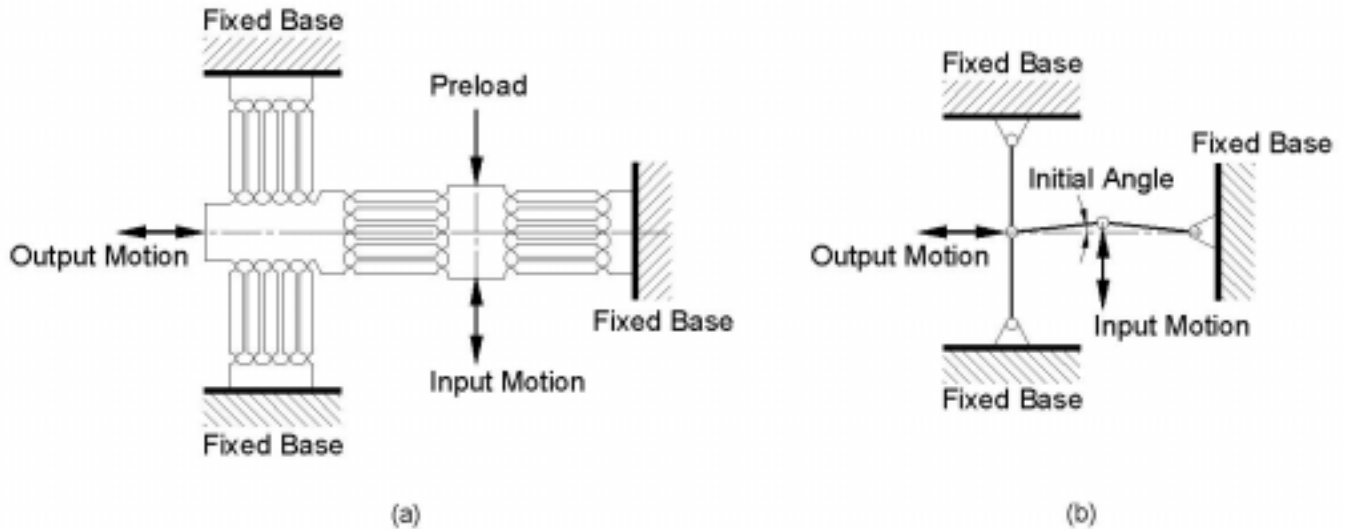

Fig. 3a. Design of the high-stiffness weak-link linear motion reduction mechanism.

Fig. 3b. Schematic of the design principle for the high-stiffness weak-link linear motion reduction mechanism.

To optimize the system stiffness, we have chosen an overconstrained mechanisms in this design. The precision of the modern photochemical machining process using lithography techniques makes it possible to construct a strain-free (or strain-limited) overconstrained mechanism on thin metal sheets. By stacking these thin metal weak-link sheets with align-pins, we can construct a solid complex weak-link structure for a reasonable cost [7,8].

We have tested the sensitivity of the weak-link linear motion reduction mechanism with a laser Doppler linear encoder. During this test, a Physik Instrumente PI-841 PZT actuator with E-501.10 amplifier [9] was used for input motion control. Fig. 4 shows the result of a calibration test. A 0.098nm/mV driving sensitivity was demonstrated with this weak-link linear motion reduction mechanism.

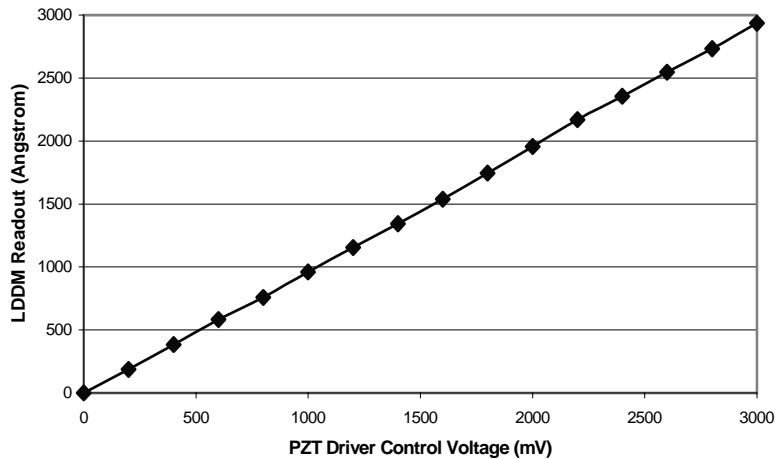

Fig. 4. Result of a calibration test for a high-stiffness weak-link linear motion reduction mechanism. The motion reduction effect with this setup is 1:15.3.

3. ONE-DIMENSIONAL LASER DOPPLER LINEAR ACTUATOR DESIGN

We have designed a one-dimensional linear actuator system based on the above high-stiffness weak-link technique and LDDM with multiple reflection optics. Fig. 5 shows a schematic of the one-dimensional laser Doppler linear actuator (LDLA) system. In this setup, a PZT-driven motion-reduction mechanism (1) was mounted on the top of a DC-motor-driven stage (2) to drive the motion object (for instance, a sample holder for atomic force microscope). A laser Doppler displacement meter (3) with an optical resolution extension assembly (4) is used to measure the sample holder motion in a 50-mm range with sub-angstrom resolution. The LDDM position signal is fed back through a system control computer (5) to control the PZT (6). The PZT drives the motion-reduction-mechanism with sub-angstrom resolution to stabilize the motion. The system control computer also synchronizes the stage position and PZT feedback lock-in point with the LDDM position signal.

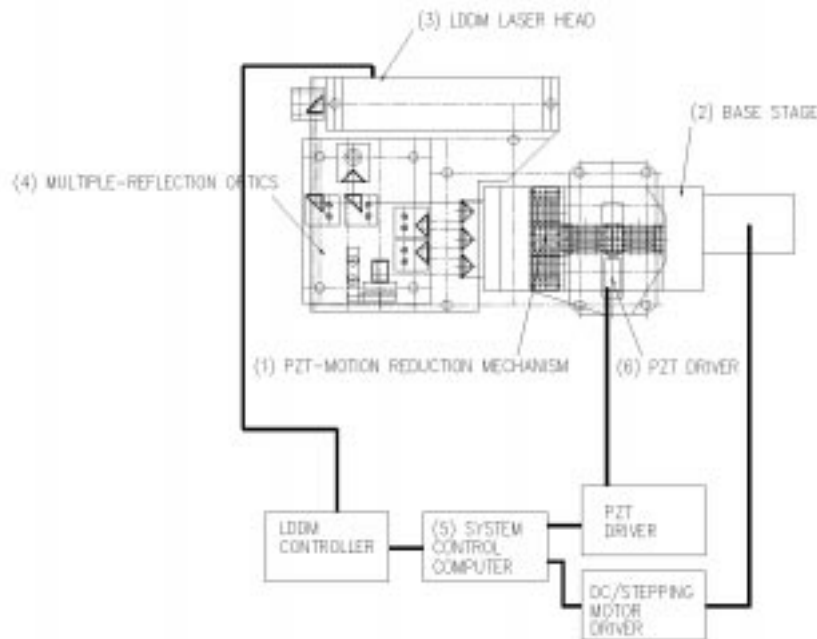

Fig. 5. Schematic of the one-dimensional laser Doppler linear actuator system.

The closed-loop motion control hardware diagram of the one-dimensional LDLA system is sketched in Fig. 6. It consists of four major functional modules: an LDDM-based position sensor, a PZT-based fine motion control, a DC/stepping-motor-based coarse motion control, and a PC-based data acquisition and control system. In addition, two signal conditioning modules are inserted before the data acquisition system. One is connected to the LDDM analog phase signal, consisting of a programmable low-pass filter for antialiasing. The other serves as digital conditioning, including jitter reduction by Schmitt triggers and signal transform to match the data acquisition counter.

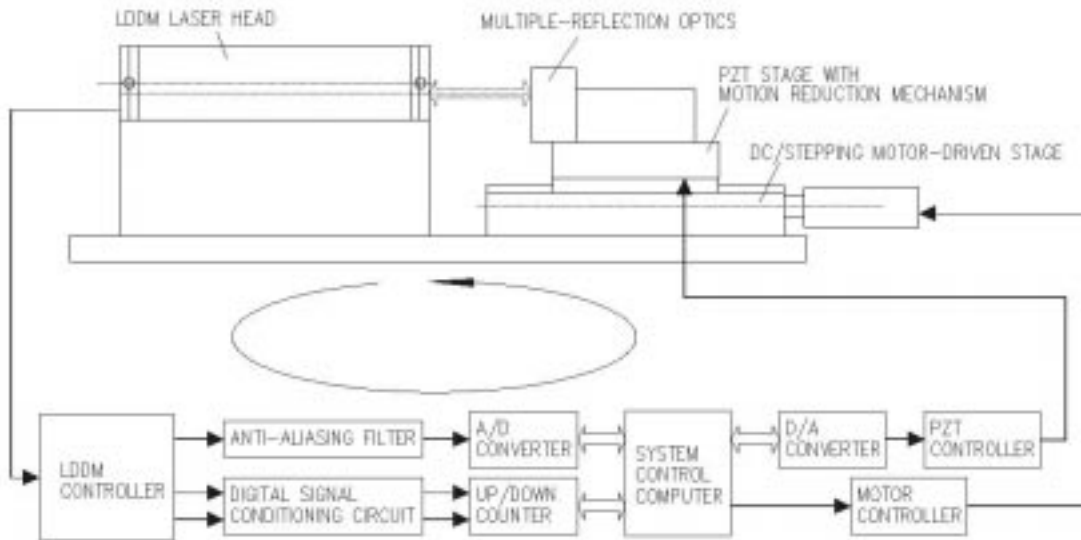

Fig. 6. Block diagram of the hardware for LDLA closed-loop motion control.

To achieve a large dynamic range of motion control, the coarse-to-fine strategy is realized by motion relay between a DC-servomotor or stepping-motor with resolution of 100 nm and a PZT actuator with a weak-link motion reduction mechanism with resolution of near 0.3 angstrom. Although both the DC-servomotor and PZT actuator have been armed with built-in closed-loop feedback control mechanism in their controllers, a PC-based system control computer is implemented to take advantage of the LDDM and its optical resolution extension techniques and to ensure the system integrity with 1-angstrom resolution and a 50-mm travel range.

The control software is designed with the National Instrument LabVIEW graphical programming language, G [10]. To improve the system dynamic performance, a LabVIEW PID toolbox has been used in the program. The complete program includes device initialization, PID control, and postprocessing. Furthermore, status monitoring and interface processing of abnormal events are necessary to ensure the control safety. The basic flow chart is shown in Fig. 7.

4. ONE-DIMENSIONAL LASER DOPPLER LINEAR ACTUATOR TEST

Recently, a preliminary test was performed for this one-dimensional laser Doppler linear actuator system. As shown in Fig. 8, a series of 1-angstrom steps has been demonstrated. A 50-mm travel range was achieved. The closed-loop control system also performed as an active vibration damping system. Fig. 9 shows the comparison of the system operating under open-loop and closed-loop control modes. Fig. 10 shows a vibration damping process caused by a single tapping on the supporting base of the testing LDLA. A comprehensive system dynamic performance study is under way.

The LDLA, which not only measures but also adjusts the position of a device, will further enhance the performance of instrumentation at the APS and is expected to have significant commercial applications as well. Fig. 11 shows a photograph of the one-dimensional LDLA test setup with an atomic-force scanning microprobe. A complete atomic-force scanning microscope using this LDLA system for large field imaging is shown in Fig. 12.

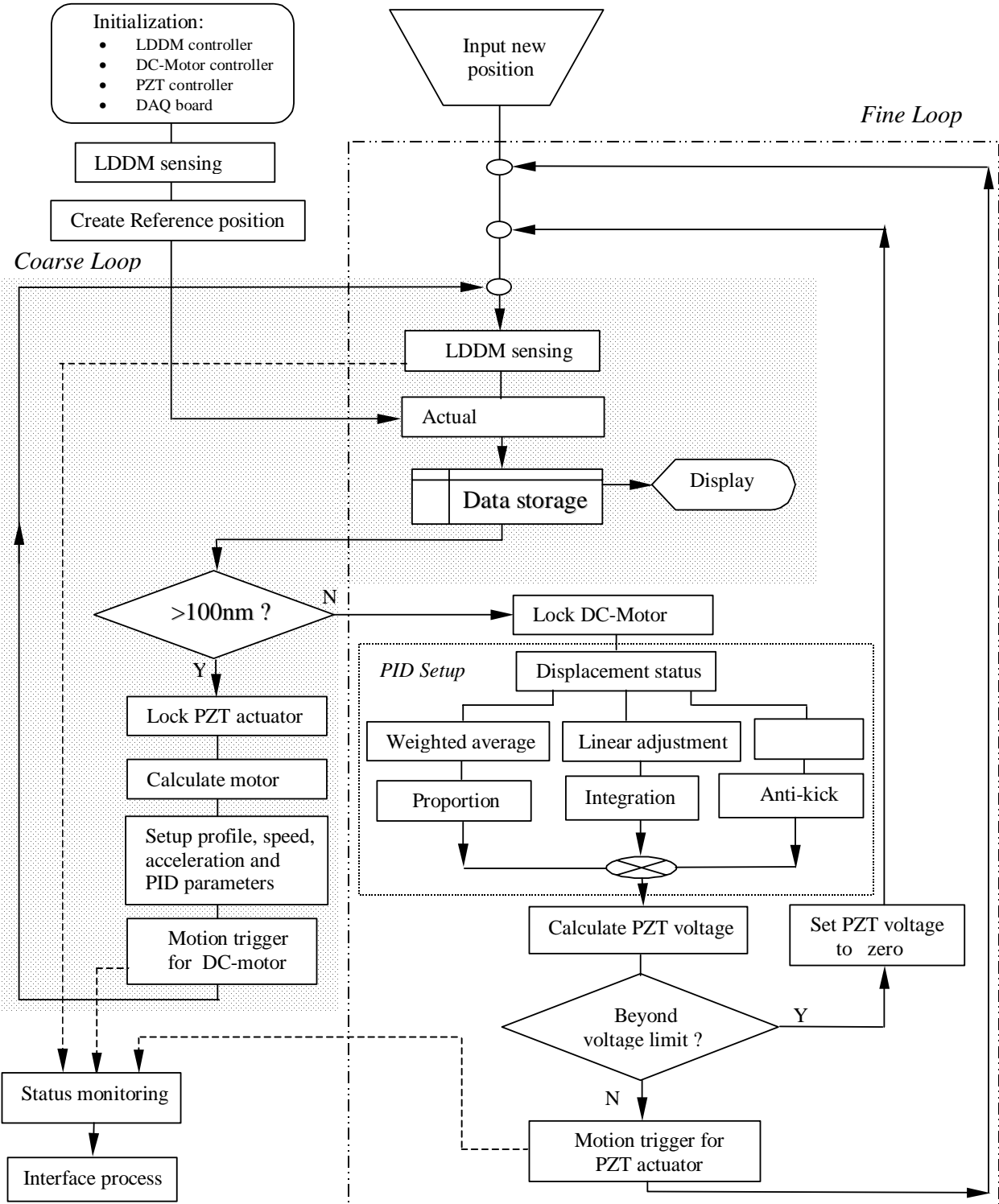

Fig. 7. Basic flow chart of the LDLA closed-loop motion control program.

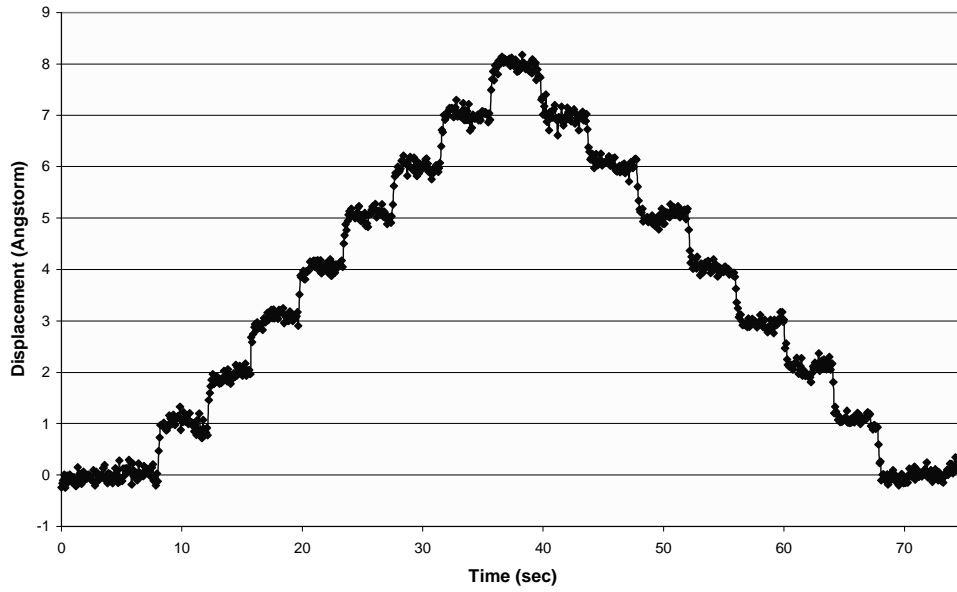

Fig. 8. Resolution test of the one-dimensional laser Doppler linear actuator closed-loop control system. A series of 1-angstrom steps has been demonstrated.

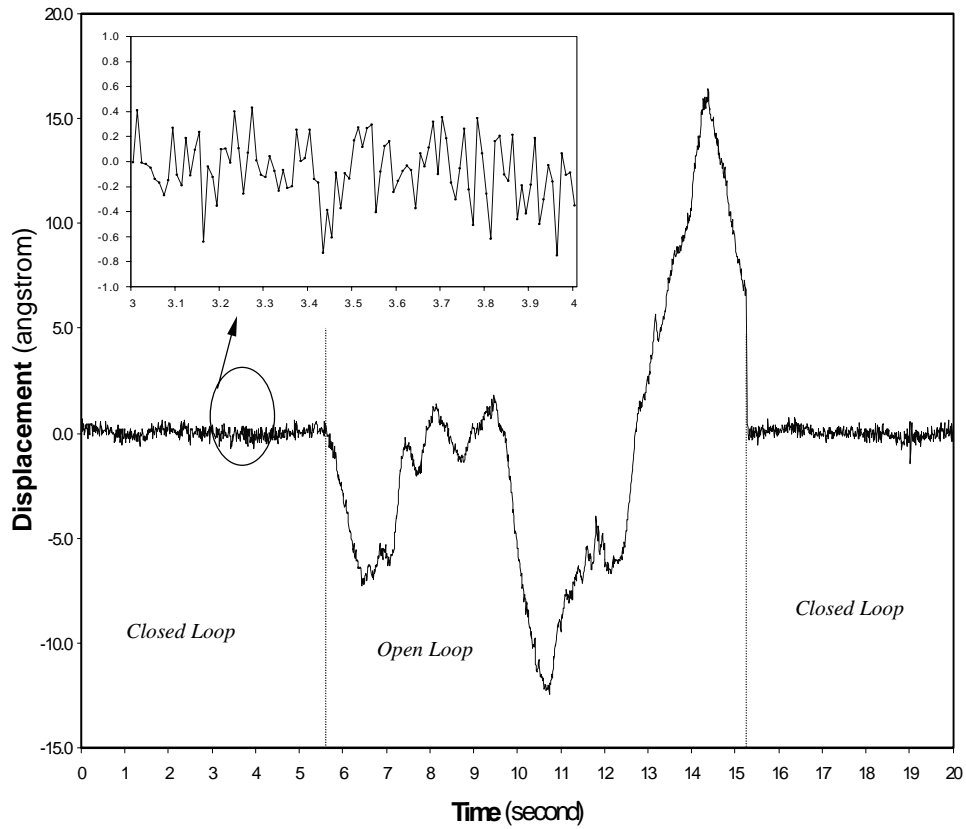

Fig. 9. Test results for comparison of the system operating under open-loop and closed-loop control modes.

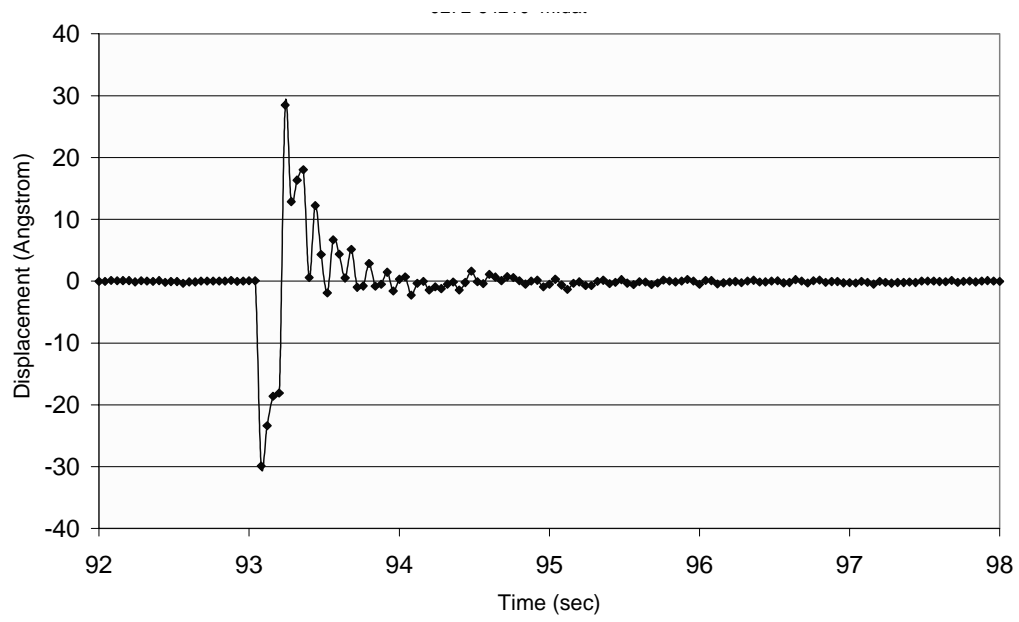

Fig. 10. Test result of a vibration-damping process caused by a single tap on the supporting base of the test LDLA.

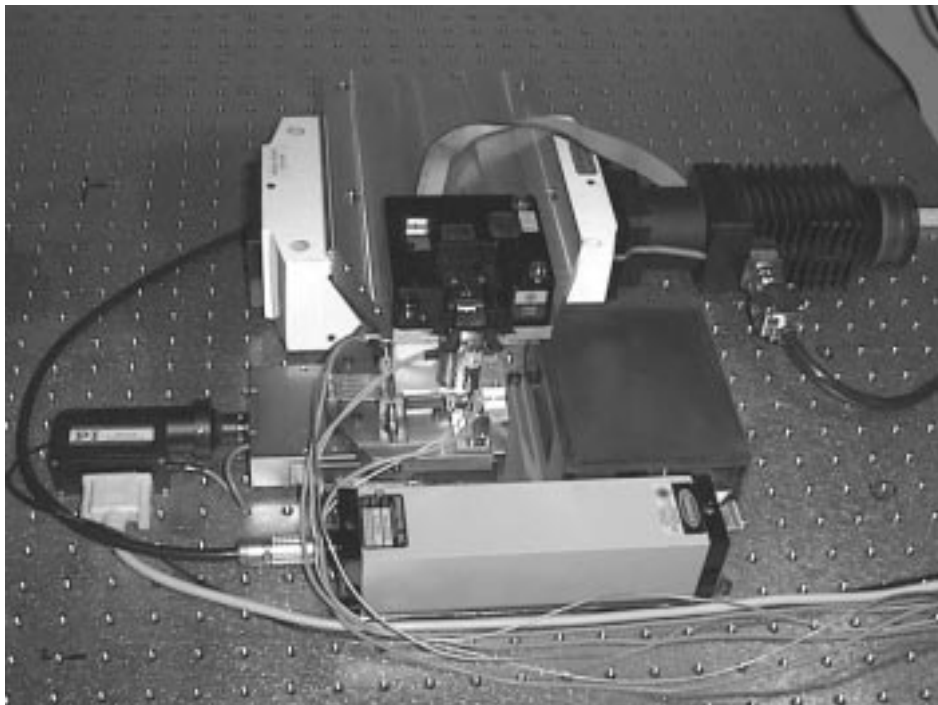

Fig. 11. Photograph of the one-dimensional LDLA test setup with an atomic-force scanning microprobe.

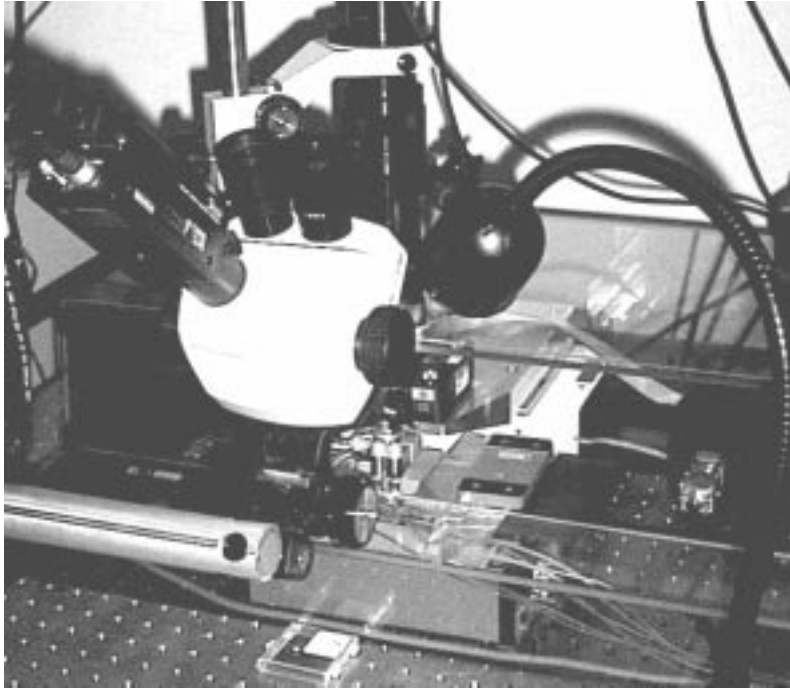

Fig. 12. Photograph of an atomic-force scanning microscope using the LDLA system for large-field imaging.

5. OPTICS FOR THE TWO-DIMENSIONAL LASER DOPPLER ENCODER

A key technical challenge for the two-dimensional ultraprecision laser encoder system is to design a multiple self-aligning optical path with 3-D motion-decoupling capability. Fig. 13 shows a schematic of a novel self-aligning 3-D multiple-reflection optical design for the LDDM system resolution extension [11]. In this design, prism 1 is mounted on a moving target, and elements 2, 3, 4, 5, and 6 are mounted on a fixed base. The target has 3-D linear motion freedom. This optics is only sensitive to the target motion in the X direction. The heterodyning detector is housed coaxially inside the frequency-stabilized laser source. Instead of a typical single reflection on the moving target, the laser beam is reflected back and forth twelve times between the fixed base and the moving target. The laser beam, which is reflected back to the heterodyning detector, is frequency-shifted by the movement of the moving target relative to the fixed base. With the same LDDM laser source and detector electronics, this optical path provides twelve-times optical resolution extension power for the linear displacement measurement and encoding.

As shown in Fig. 13, the laser beam is reflected by a set of right-angle prisms 1, 2, and 3. Prism 4 reflects the beam back to a different zoom on prisms 1, 2, and 3. On retroreflector 5, the laser beam is reflected back to the laser head, following the original path and finally reaching the detector, which is arranged coaxially in the laser-head housing 6. The use of the retroreflector 5 provides for a very practical self-alignment capability. It reduces the total system assembly and alignment time substantially. Because the laser beam is reflected in the same optical path twice with opposite directions, this multiple-reflection optical design provides unique system stability performance. The 3-D optical path configuration results in a compact and integrated optical design that optimizes the system's antivibration performance, which is critical for sub-angstrom resolution in measurements.

Fig. 14 explains the mathematic principle of this optical design. To compare the total optical path length before and after a prism incremental movement Δ in the Z direction, which is perpendicular to the prism 1 measuring-direction X. Since the total optical path length Δ , which is the sum of the optical paths A to L, is always equal to the original optical path length Δ_0 ,

which is the sum of the optical paths A_0 to L_0 , this optics is decoupled to the incremental movement Δ in the Z direction. The motion measurement decoupling in the Y direction is obvious. This optics design has been tested with a computer aided simulation and a prototype experimental setup.

There are many ways to change the total number of a reflection times in this design. For instance, to expand the optical path in the Y direction, one can add more prisms on the sides of prism 4 and retroreflector 5 to expand the optical path in the Y direction to perform a 24-times optical resolution extension power as shown in Fig. 15. The limit of the maximum reflection times is determined by the optical reflectivity of the reflecting element to be used and the sensitivity of the LDDM laser detector electronics. Special coatings could be used on the surfaces of the reflecting elements to optimize the results.

This optics provides a technique for three-dimensional measurement with atomic scale resolution and large two-dimensional measuring range (up to 50 mm or more).

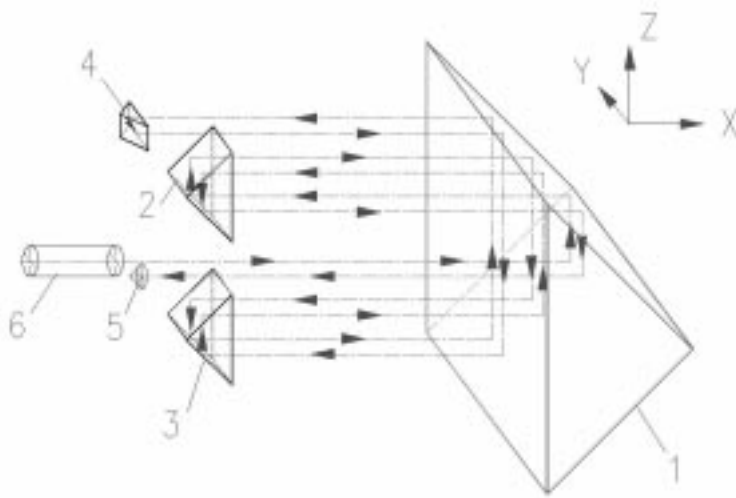

Fig. 13. Schematic diagram of a multiple self-aligned optical path design with 3-D motion decoupling capability.

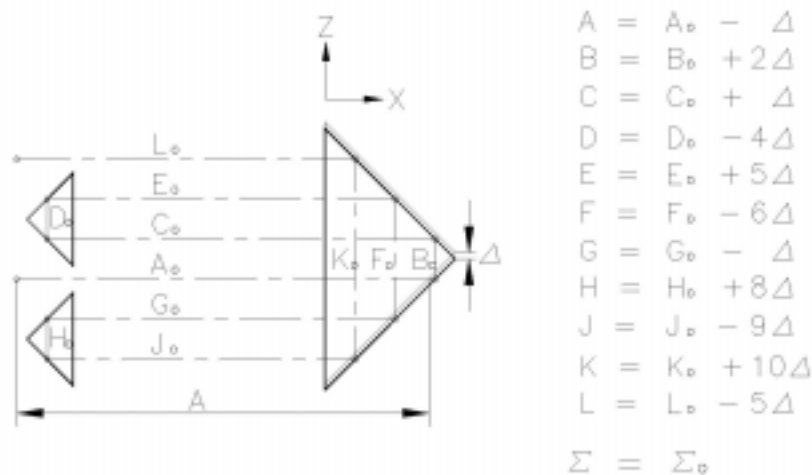

Fig. 14. Diagram of the mathematic principle of the multiple self-aligned optical path design with 3-D motion decoupling capability.

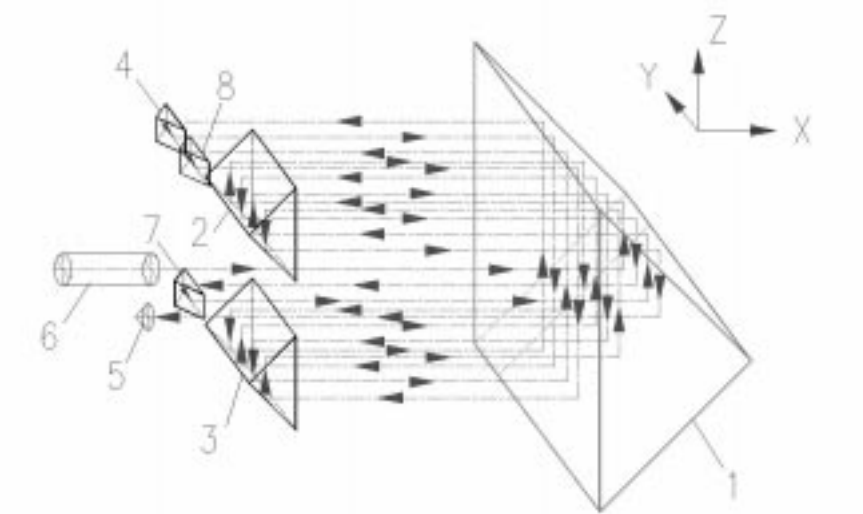

Fig. 15. Schematic diagram of a multiple self-aligned optical path design with a 24-times optical resolution extension power.

6. DESIGN OF THE TWO-DIMENSIONAL LASER DOPPLER LINEAR ACTUATOR

We have designed and constructed a two-dimensional (2-D) laser Doppler linear actuator system with closed-loop control. As shown in Fig. 16, the 2-D LDLA system consists of two sets of one-dimensional LDLA. The actuator system combines four motion stages. The two base stages are commercial DC-motor-driven stages with 100-nm resolution and 50-mm travel range. The two weak-link stages, which are mounted on the top of the base stages, are high-stiffness, PZT-driven, compact motion-reduction mechanisms with 0.3-angstrom resolution. These motion-reduction mechanisms with sub-angstrom resolution and a 2-kg vertical loading capacity are key components for the motion feedback control. A new modular structure based on the same principal has been designed and optimized for this 2-D actuator use. The finite element analysis method was used in the optimization process.

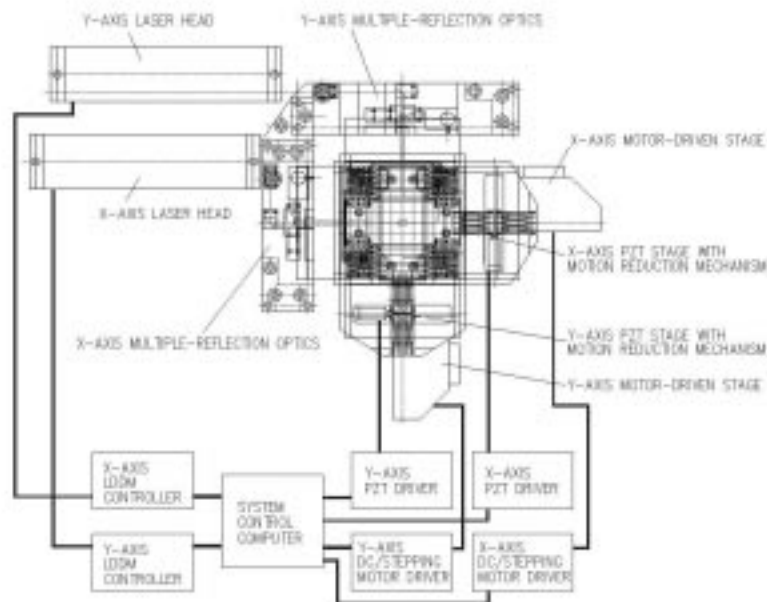

Fig. 16. Schematic of the 2-D laser Doppler linear actuator system.

The system is in testing and commissioning now. Preliminary testing has demonstrated its subnanometer positioning capability. This prototype will be used as part of a dynamic test station for x-ray nanoprobe development at the APS. Fig. 17 is a photograph of the 2-D laser Doppler linear actuator system test setup.

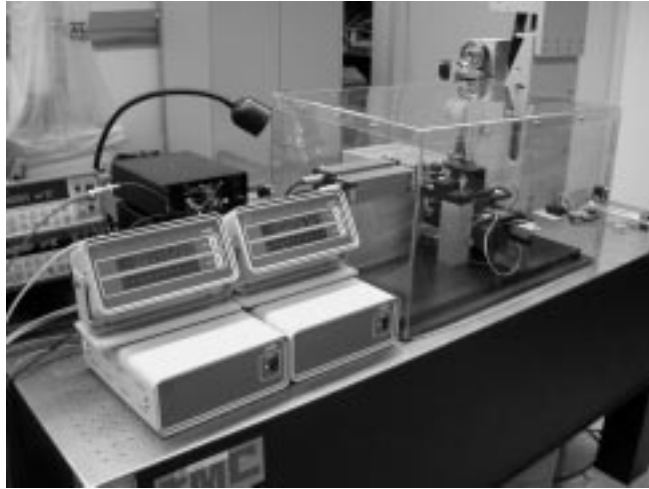

Fig. 17. Photograph of the two-dimensional LDLA test setup.

7. DISCUSSION AND CONCLUSIONS

We have built and tested a one-dimensional laser Doppler linear actuator system with 1-angstrom closed-loop control resolution and a 50-mm travel range. Two special techniques were developed for this ultraprecision motion control system. A laser Doppler encoder system with multiple-reflection optics has demonstrated its sub-angstrom linear sensitivity. A specially designed high-stiffness weak-link linear motion reduction mechanism provided sub-angstrom driving sensitivity with high stability. The closed-loop control system also performed as an active vibration-damping system.

We have also developed and tested a novel optics for a 2-D laser Doppler displacement meter resolution extension with three-dimensional motion decoupling capability. A 2-D laser Doppler linear actuator system is in testing and commissioning now. Preliminary testing has demonstrated its near-angstrom positioning capability.

The LDLA will further enhance the instrument performance with its unique active antivibration function on the nanometer scale. We expect that this 2-D laser Doppler linear actuator system will have broad measurement applications for novel nanoscale science and technologies. Further developments of the LDLA system are focused on the compactness of the 2-D system and optics of differential measurements for x-ray nanoprobe applications.

ACKNOWLEDGMENT

The authors would like to thank R. Ranay, D. Nocher, C. Preissner, M. Muscia, and A. Nyman from Argonne National Laboratory, and Dr. C. Wang from Optodyne, Inc. for their help with the experiment. This work was supported by the U.S. Department of Energy, Office of Science, under contract W-31-109-Eng-38.

REFERENCES

- [1] D. Shu, E. E. Alp, J. Barraza, T. M. Kuzay, and T. Mooney, A Novel Laser Doppler Linear Encoder Using Multiple-Reflection Optical Design for High Resolution Linear Actuator, Proc. SPIE, Vol.3429 (1998) 284-292.

- [2] D. Shu, T. Toellner, and E. E. Alp, Novel Miniature Multi-Axis Driving Structure with Nanometer Sensitivity for Artificial Channel-Cut Crystals, Synchrotron Radiation Instrumentation: Eleventh US National Conference, ed. P. Pianetta, Am. Inst. Physics, Conf. Proceedings vol. 521 (2000) 219.
- [3] LDDM is a trademark of the Optodyne Inc., 1180 Mahalo Place, Compton, CA 90220, U.S.A.
- [4] Wang C. P., (1987), Laser & Optronics, Sept., pp69-71.
- [5] Wang C. P., (1977), American Scientist, 65 (3), pp289-293.
- [6] U.S. Patent granted No. 5,896,200, Optical design for laser encoder resolution extension and angular measurement, D. Shu, 1999.
- [7] D. Shu, T. Toellner, E. Alp, (1999), Patent application in progress.
- [8] D. Shu, T. S. Toellner, and E. E. Alp, Modular Overconstrained Weak-Link Mechanism for Ultraprecision Motion Control, Nucl. Instrum. and Methods A 467-468, (2001)771-774.
- [9] Physik Instrumente (PI) is a trademark of the Physik Instrumente GmbH & Co. Germany
- [10] LabVIEW is a trademark of the National Instrument Inc. U. S. A.
- [11] D. Shu, (2001), Patent application in progress.